

KI7207

Sac Shopping pliable

- 100% coton: très bonne résistance à la chaleur pour une personnalisation en sérigraphie.
- Respect de l'environnement: conçu en coton biologique.
- Pratique: Le sac se replie sur lui-même dans sa propre pochette



100% coton biologique. Le sac se replie sur lui-même dans sa propre pochette fermée par un cordon. Certifié STANDARD 100 by OEKO-TEX® N° CQ 1164/1 IFTH.



Tableau équivalence des tailles par pays en dernière page.



Informations Complémentaires

Logistique



Pays d'origine



Code douanier



KI7207

Sac Shopping pliable

Dimensions (cm)

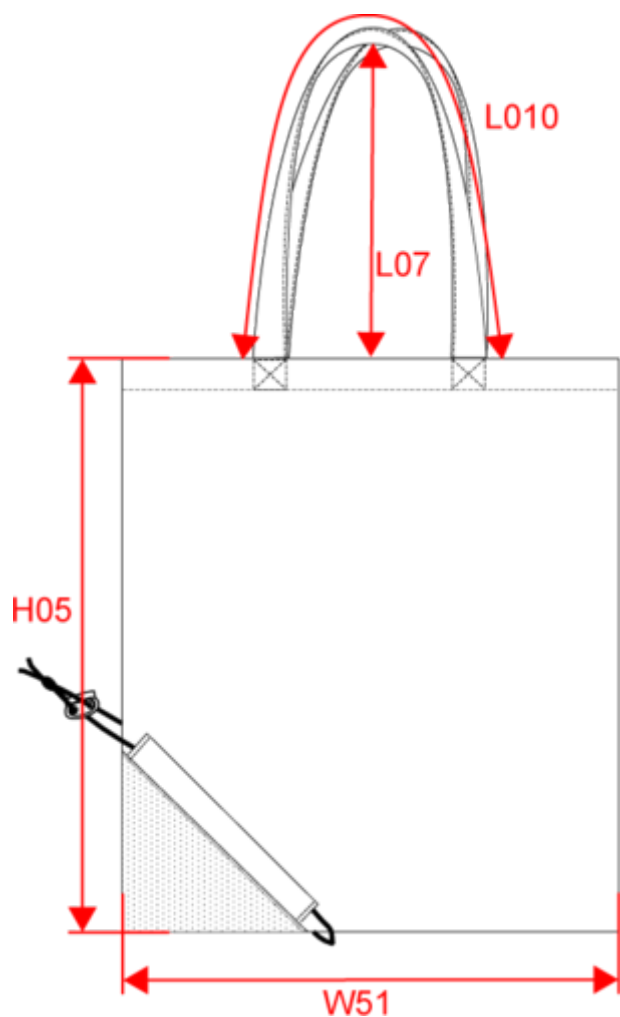







Mesures en cm	One size
H05 - Hauteur totale	42.00
L010 - Longueur bande épaule	40.00
L07 - Hauteur anses	20.00
W51 - Largeur totale	38.00



KI7207

Sac Shopping pliable

Informations Couleurs

 Natural RVB : 229,227,215 Pantone C : 7534C Pantone TCX : 12-0404TCX	 Natural RVB : 229,227,215 Pantone C : 7534C Pantone TCX : 12-0404TCX	Black RVB : 35,35,37 Pantone C : Black Pantone TCX : 19-4004TCX	 Natural RVB : 229,227,215 Pantone C : 7534C Pantone TCX : 12-0404TCX	Curcuma RVB : 179,126,37 Pantone C : 146C Pantone TCX : 18-0935TCX	 Natural RVB : 229,227,215 Pantone C : 7534C Pantone TCX : 12-0404TCX	Hibiscus Red RVB : 134,27,47 Pantone C : 1815C Pantone TCX : 19-1656TCX	 Natural RVB : 229,227,215 Pantone C : 7534C Pantone TCX : 12-0404TCX	Ice Mint RVB : 182,228,225 Pantone C : 573C Pantone TCX : 13-4909TCX
 Natural RVB : 229,227,215 Pantone C : 7534C Pantone TCX : 12-0404TCX	Navy Blue RVB : 41,45,57 Pantone C : 433C Pantone TCX : 19-4010TCX	 Natural RVB : 229,227,215 Pantone C : 7534C Pantone TCX : 12-0404TCX	Turquoise RVB : 49,180,207 Pantone C : 632C Pantone TCX : 16-4535TCX					

Logistique  1  200

Sizes	Width (cm)	Height (cm)	Length (cm)	Net weight (kg)	Gross weight (kg)	Pieces/Box	Pieces/Bundle
One Size	40	25	44	7	8.15	200	1